

MIGS : Minimally Invasive Glaucoma Surgery

Dr : Saladin Mugharbel

MIGS

- Introduction

The cardinal features of MIGS

- Ab interno, micro-incisional approach
- Minimal trauma
- Reliable IOP lowering
- High safety profile
- Rapid post-op recovery

MIGS types:

- Increase trabecular outflow
- Increase uveoscleral –suprachoroidal-supraciliary outflow
- Increase subconjunctival outflow
- Decrease aqueous production

MIGS: increase trabecular outflow

- iStent Micro-Bypass
- Gonioscopy-Assisted Transluminal trabeculotomy (GATT)
- Trabectome
- TRAB 360 Trabeculotomy
- Kahook Dual Blade
- Ab interno canaloplasty
- Hydrus Microstent

MIGS : increase uveoscleral outflow

- Cypass Micro-Stent
- iStent Supra

MIGS : increase subconjunctival outflow

- XEN Glaucoma Treatment System
- innFocus micro shunt

MIGS : decrease aqueous production

- Endocyclophotocoagulation

MIGS : iStent (*Glaucoose corporation*)

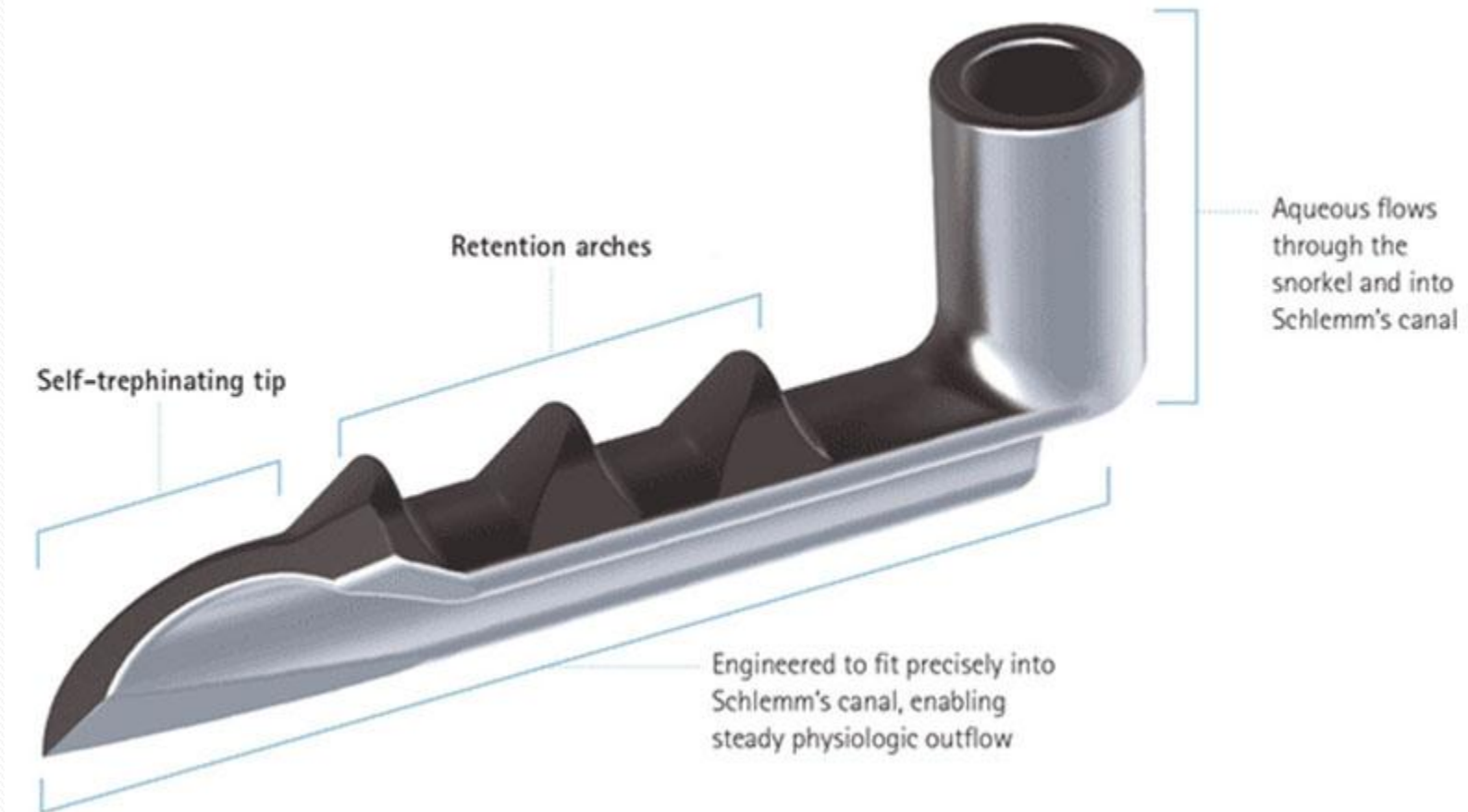

MIGS : iStent (Glaucoose corporation)

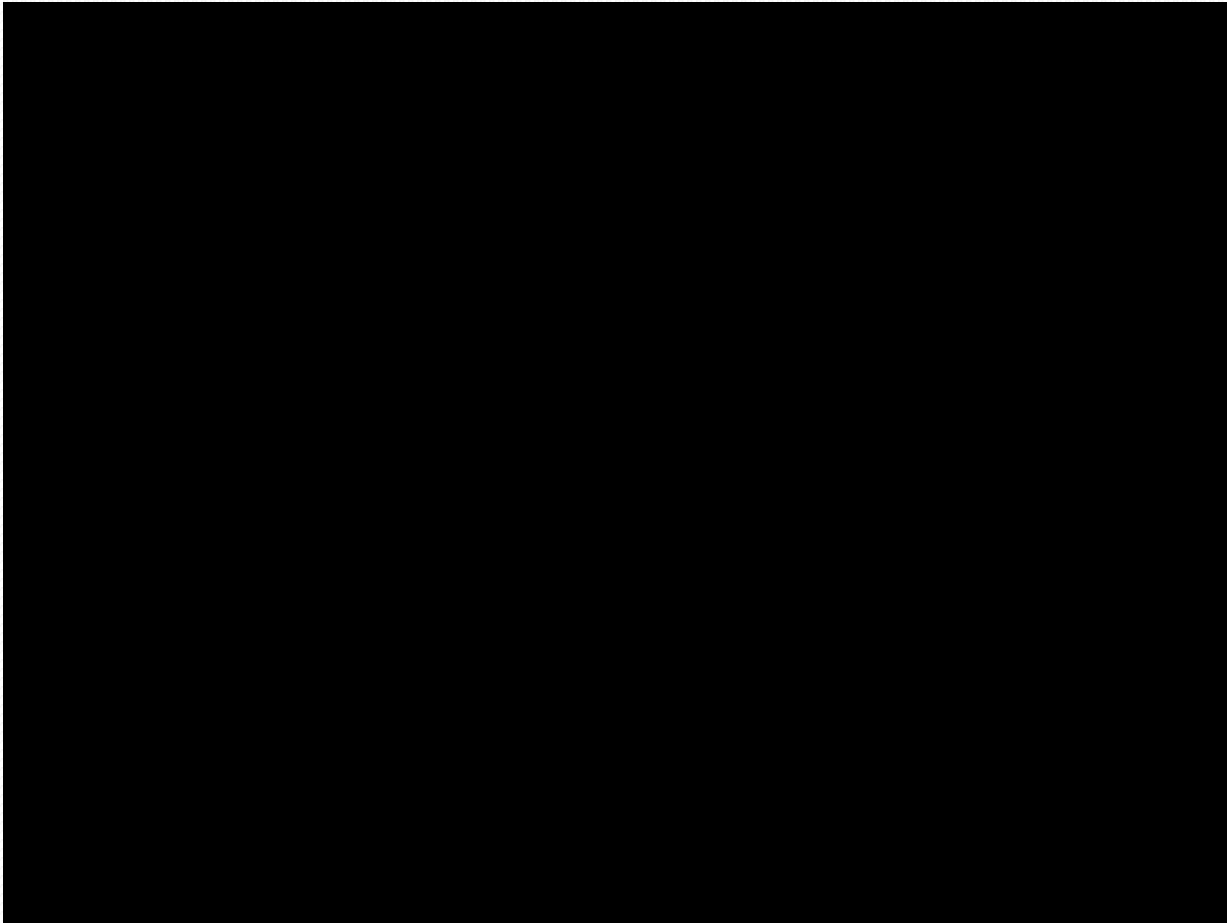

MIGS : iStent Inject (the 2nd generation)

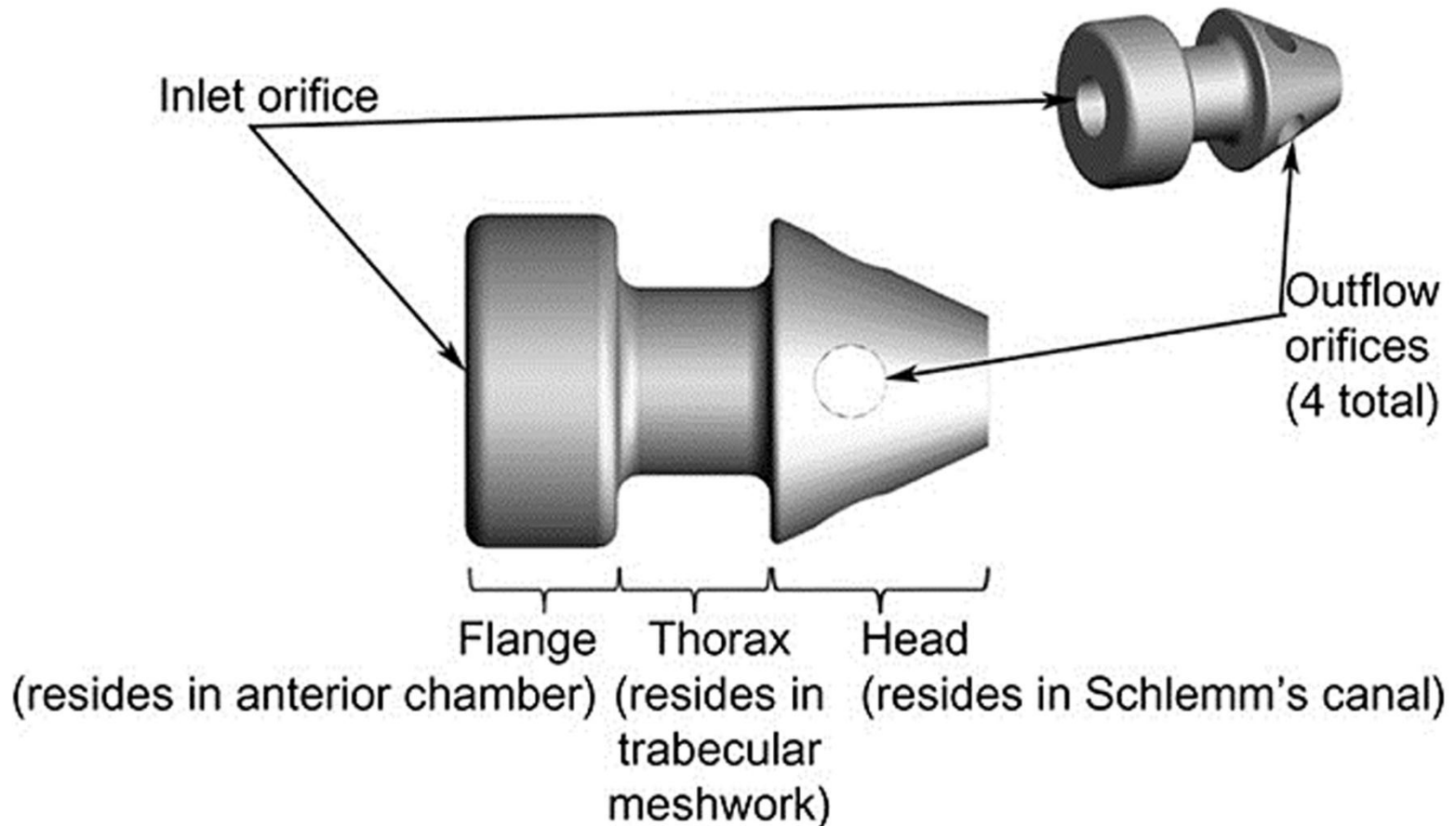

MIGS : GATT Gonioscopy Assisted Transluminal Trabeculotomy

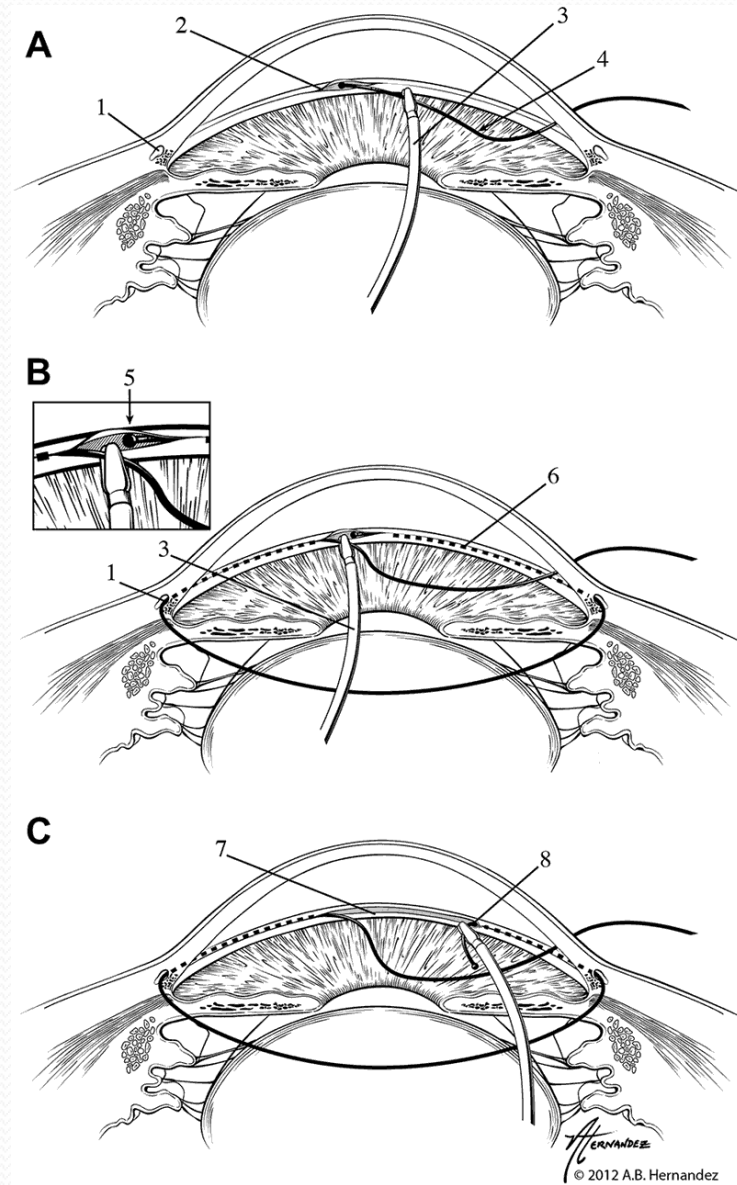

Used with permission from Elsevier

MIGS : GATT

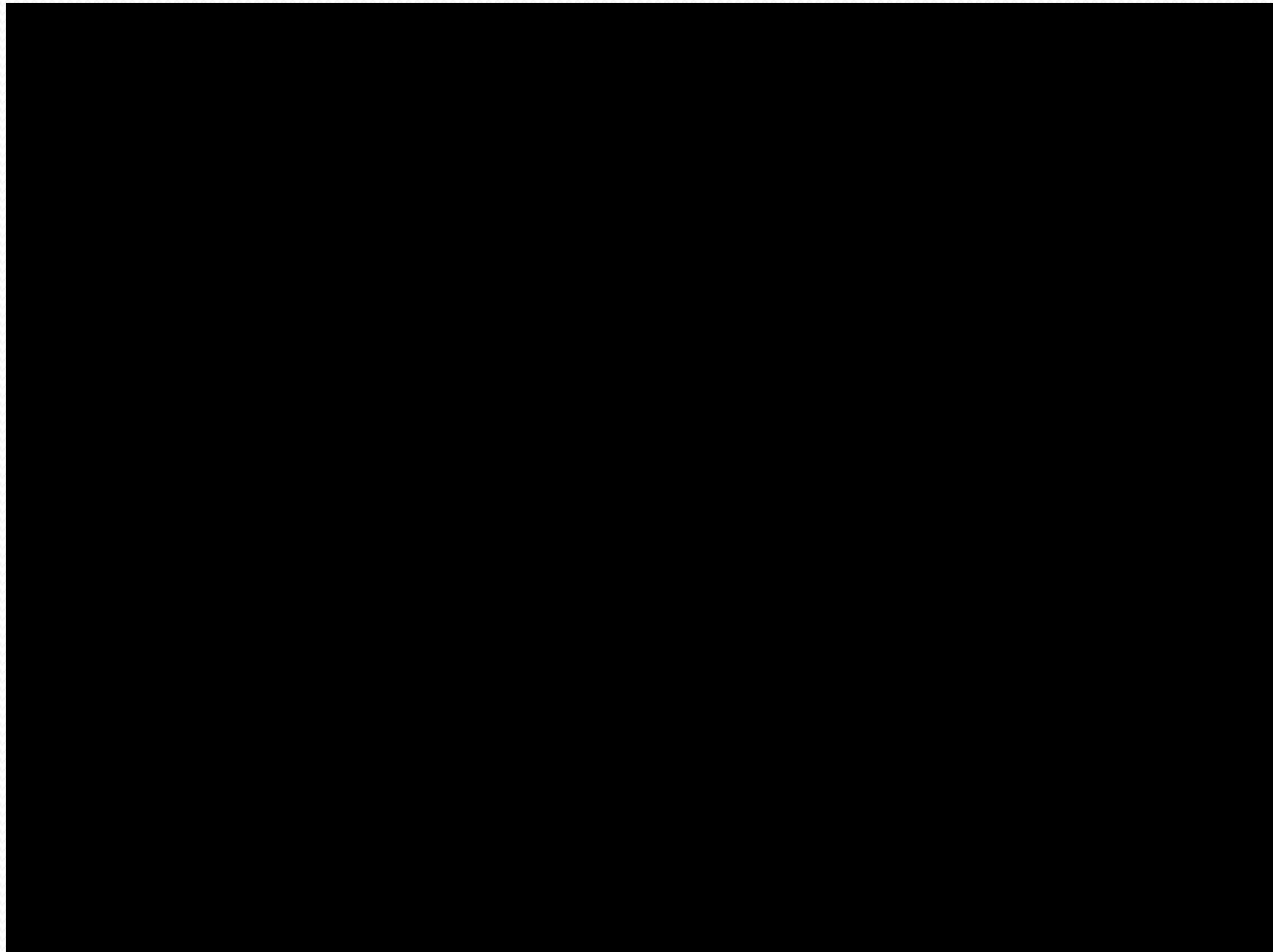

MIGS : TRAB 360 Trabeculotomy

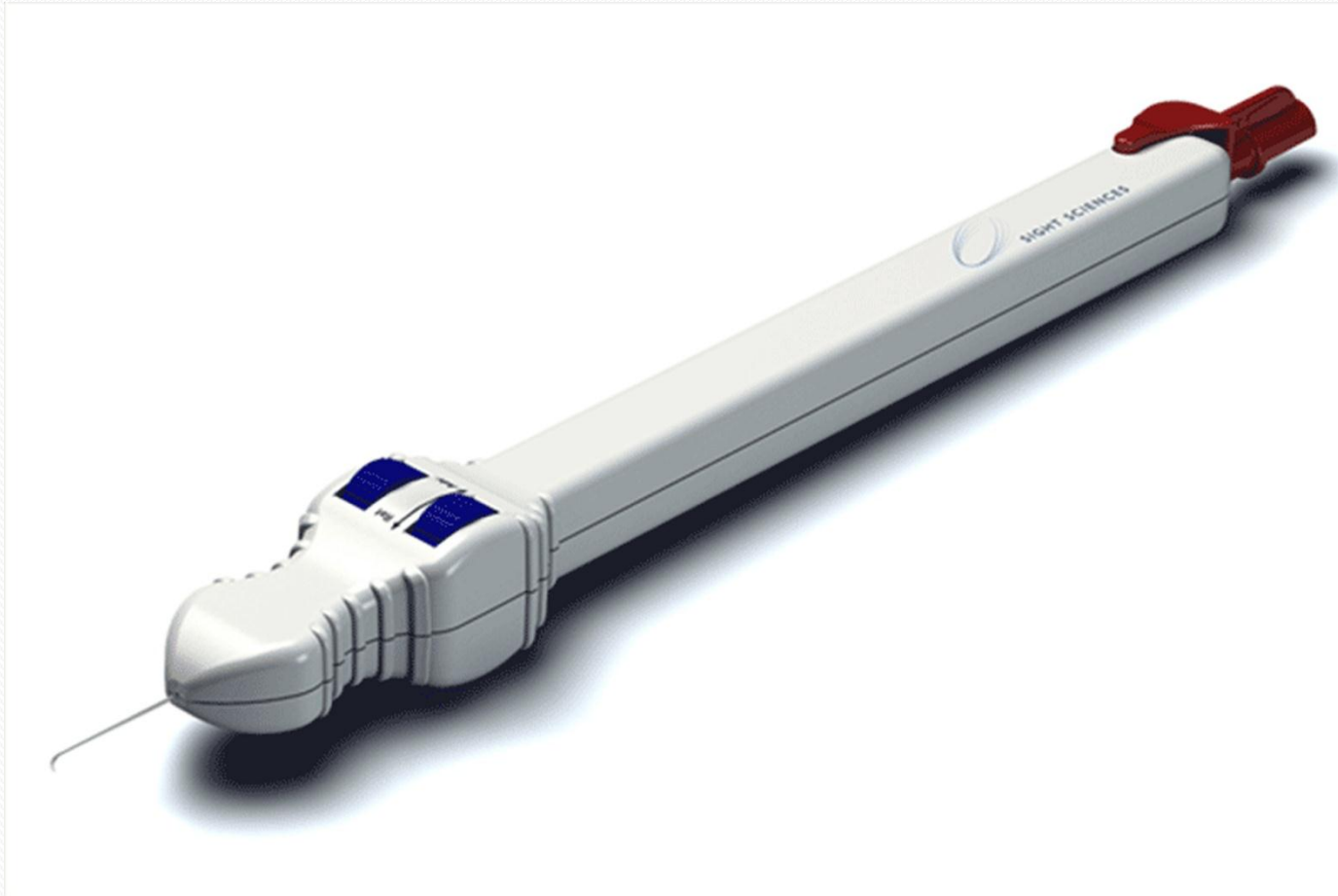

MIGS : TRAB 360 Trabeculotomy

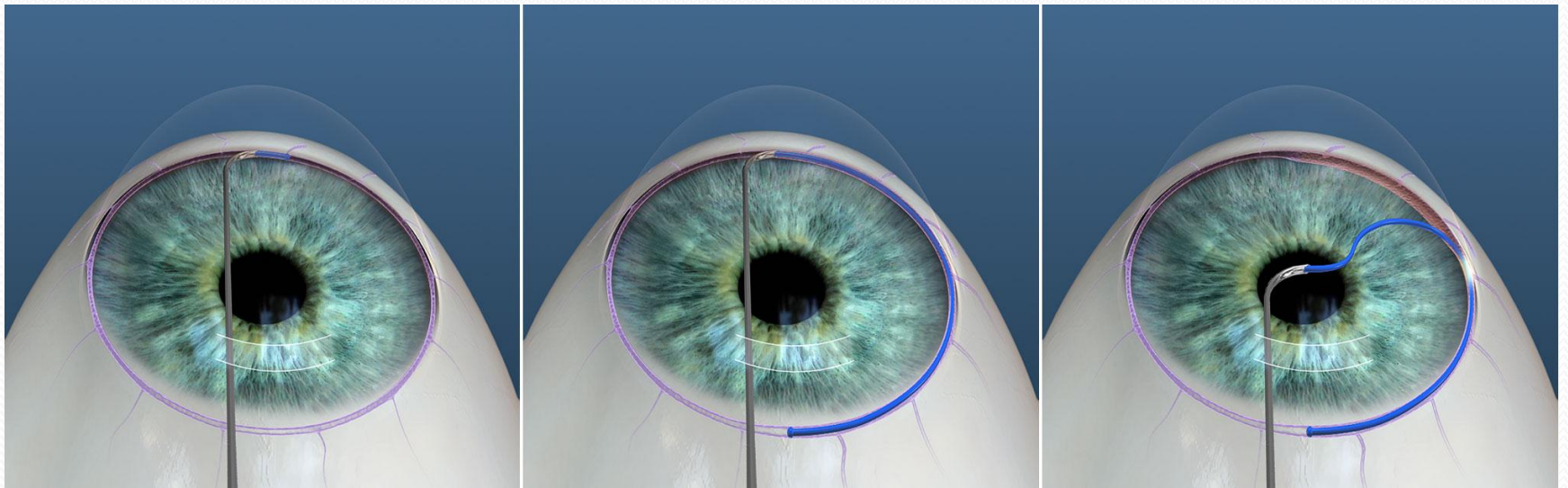

MIGS : Trabectom (NeoMedix Inc.)

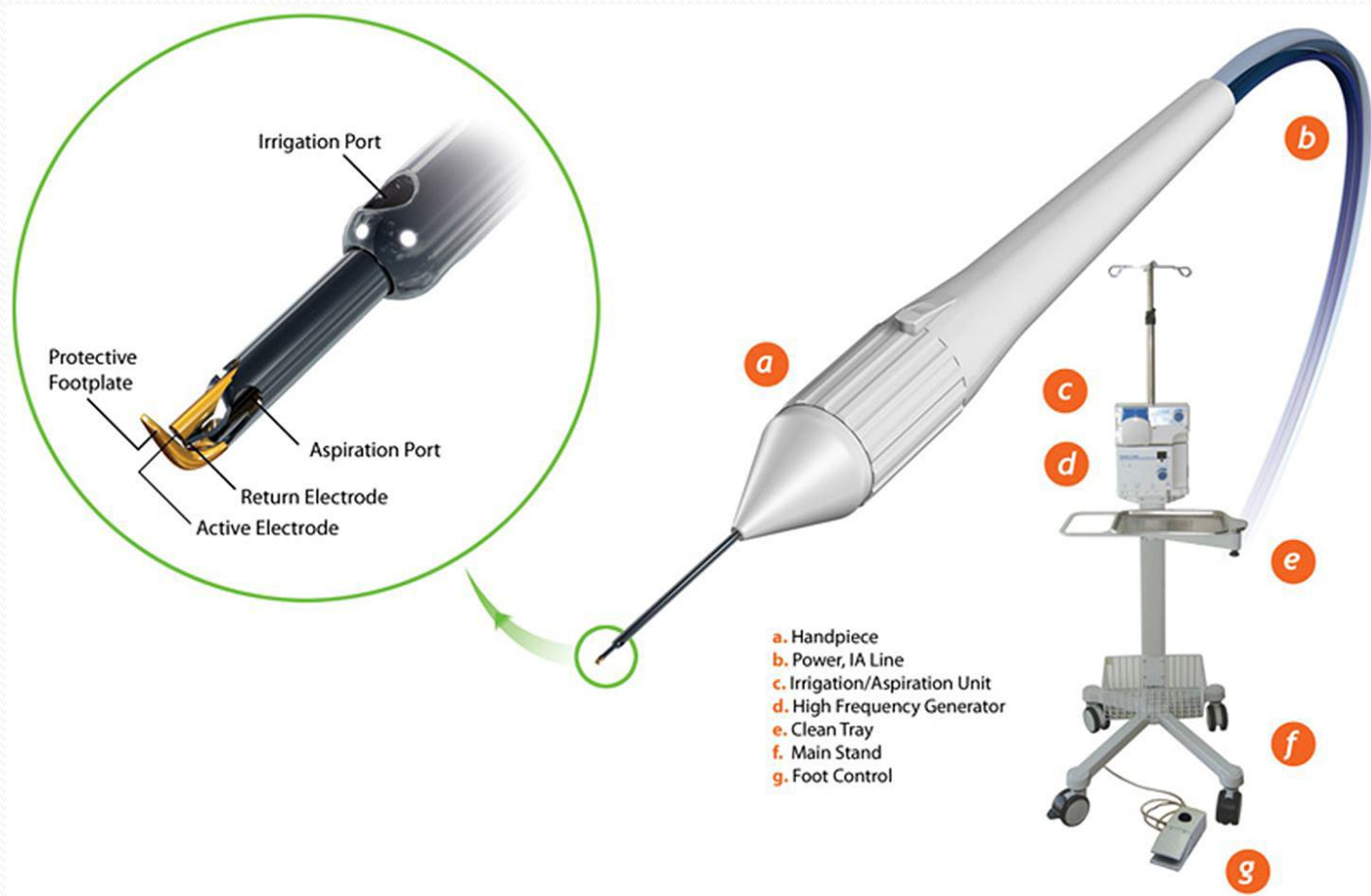

MIGS : Trabectom (NeoMedix Inc.)

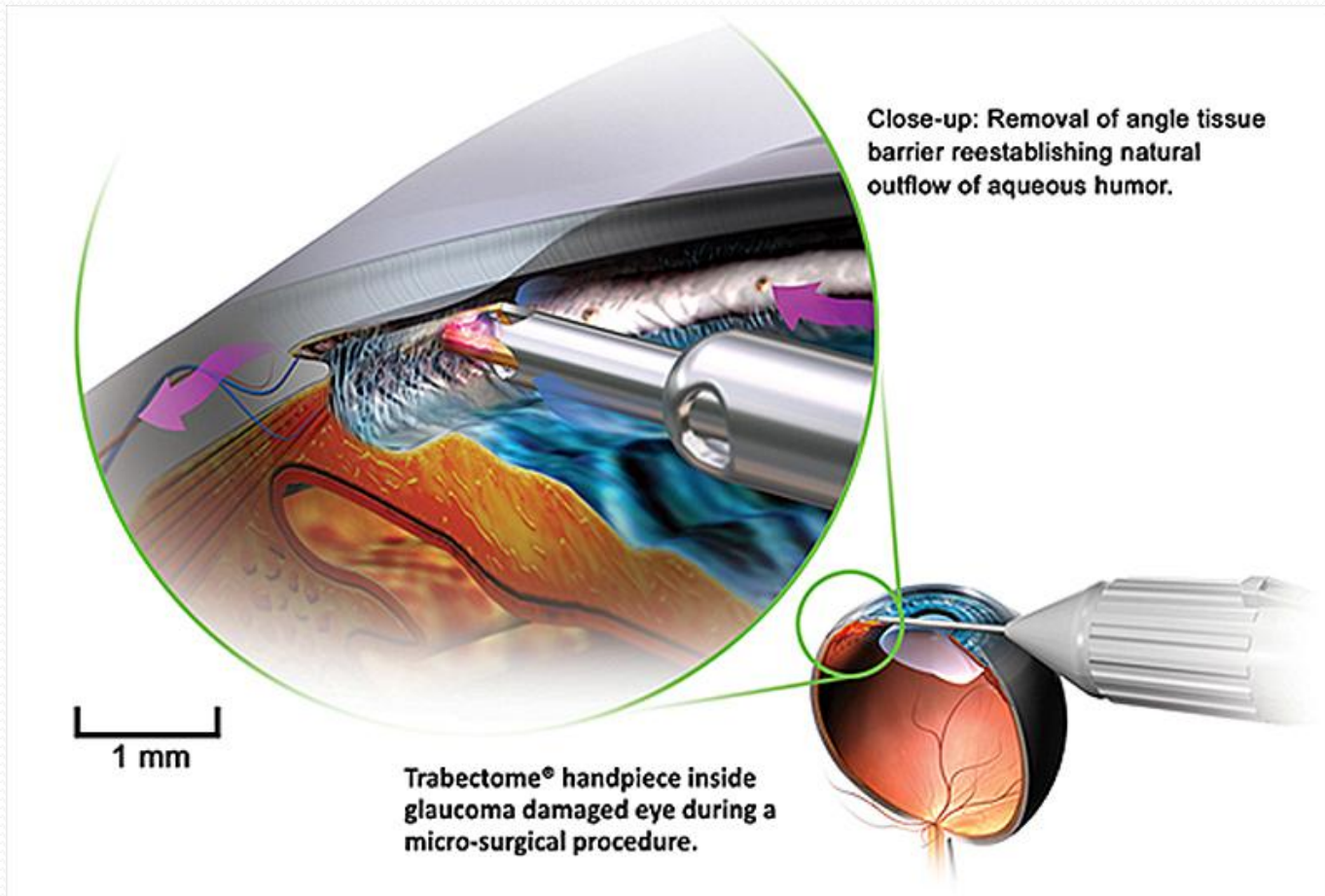

MIGS : Kahook Dual Blade



MIGS : Kahook Dual Blade

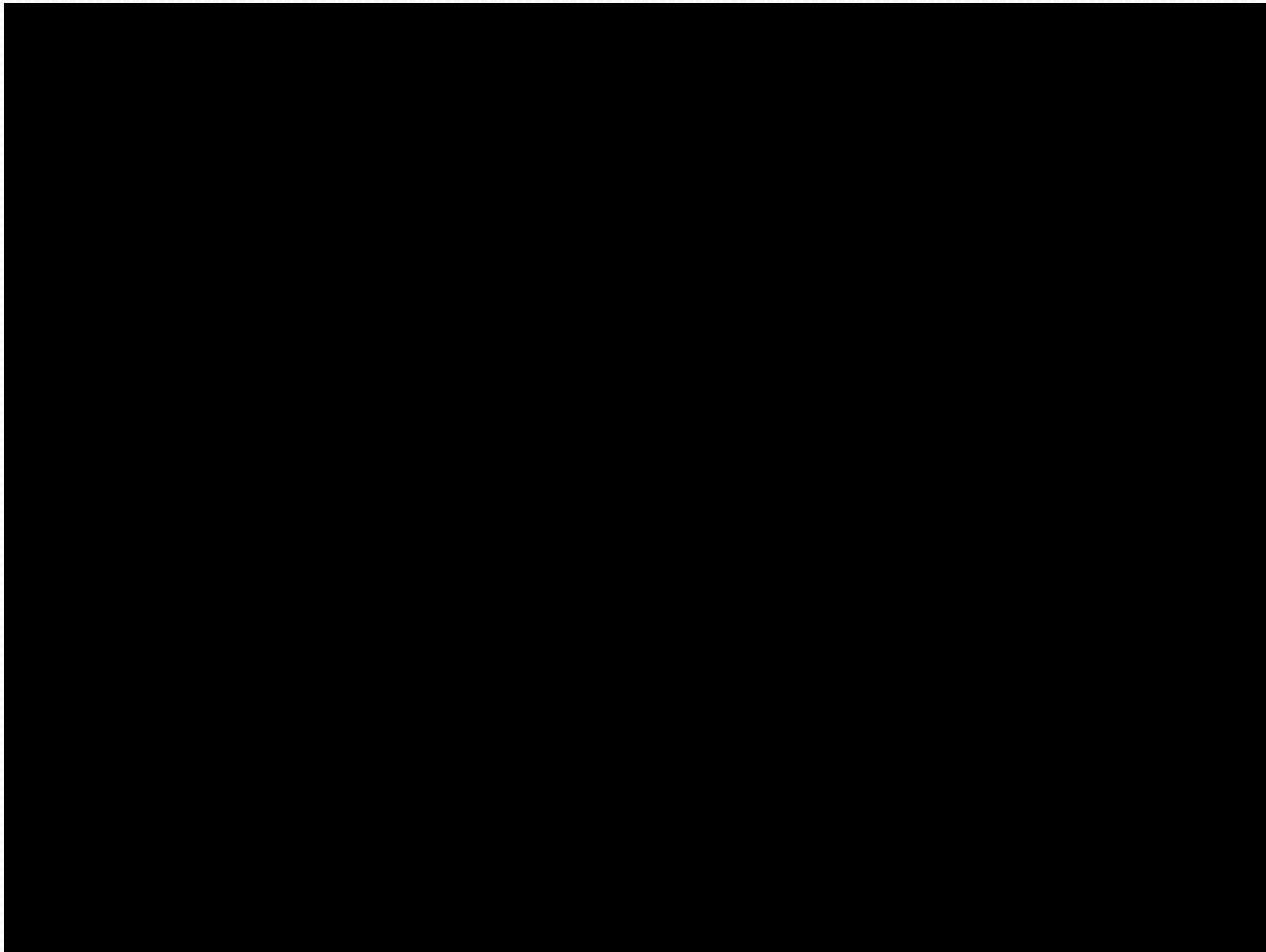

MIGS : ABIC Ab Interno Canaloplasty

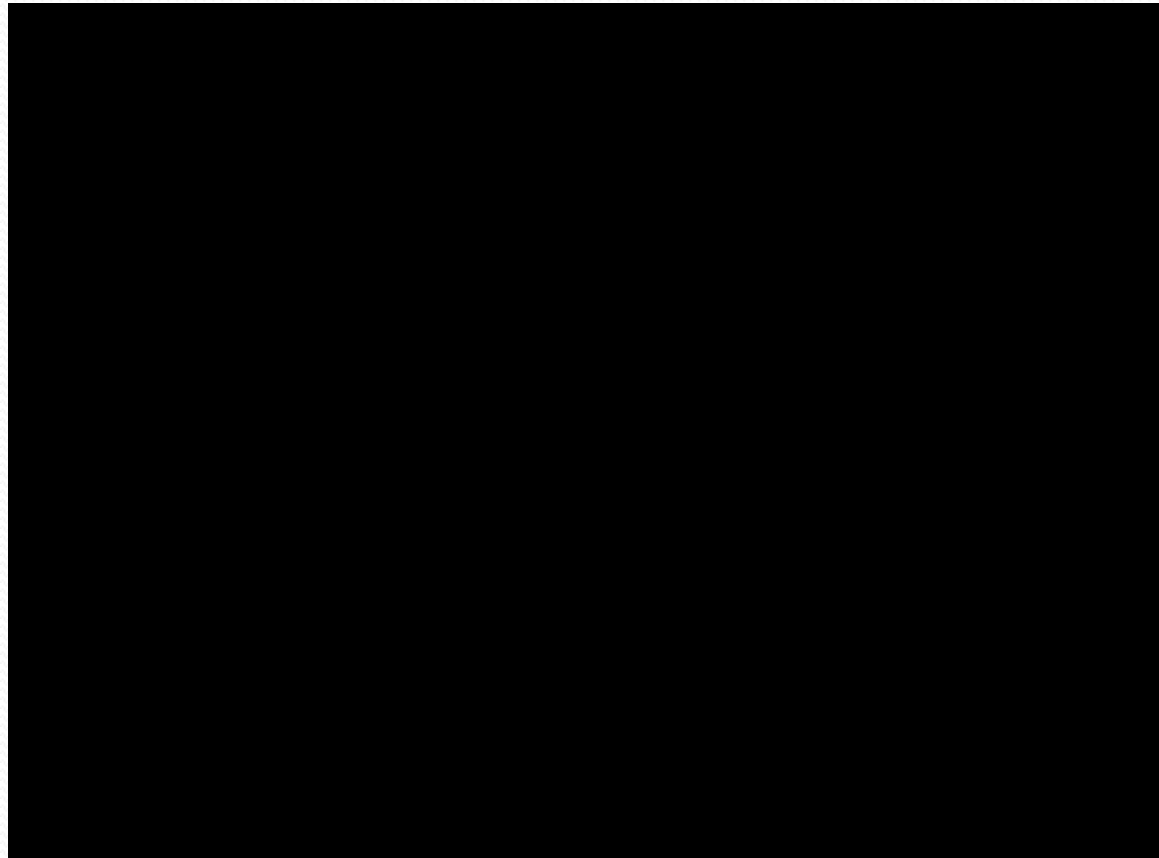

MIGS : VISCO 360 *(Sight Sciences)*

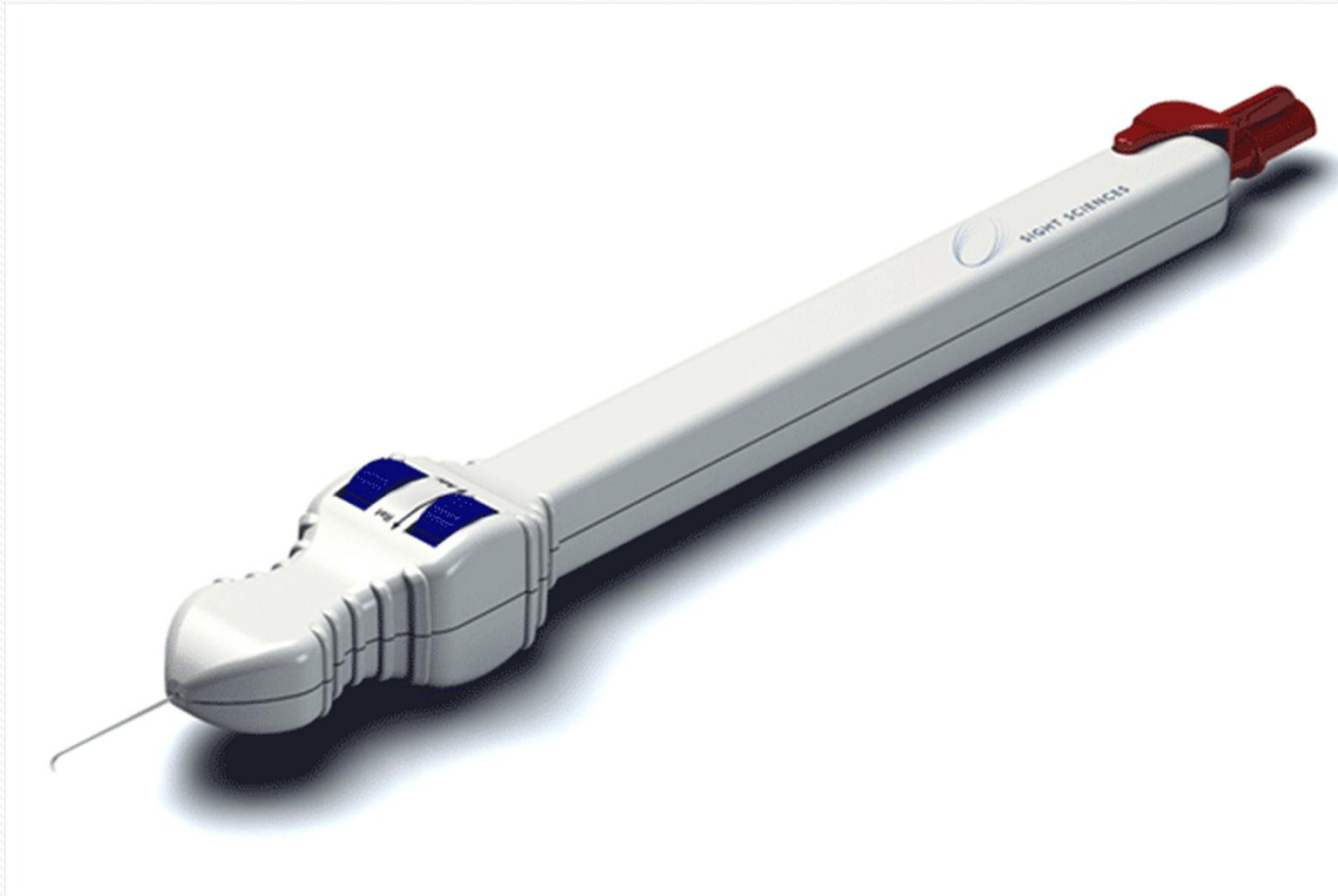

MIGS : VISCO 360 (*Sight Sciences*)

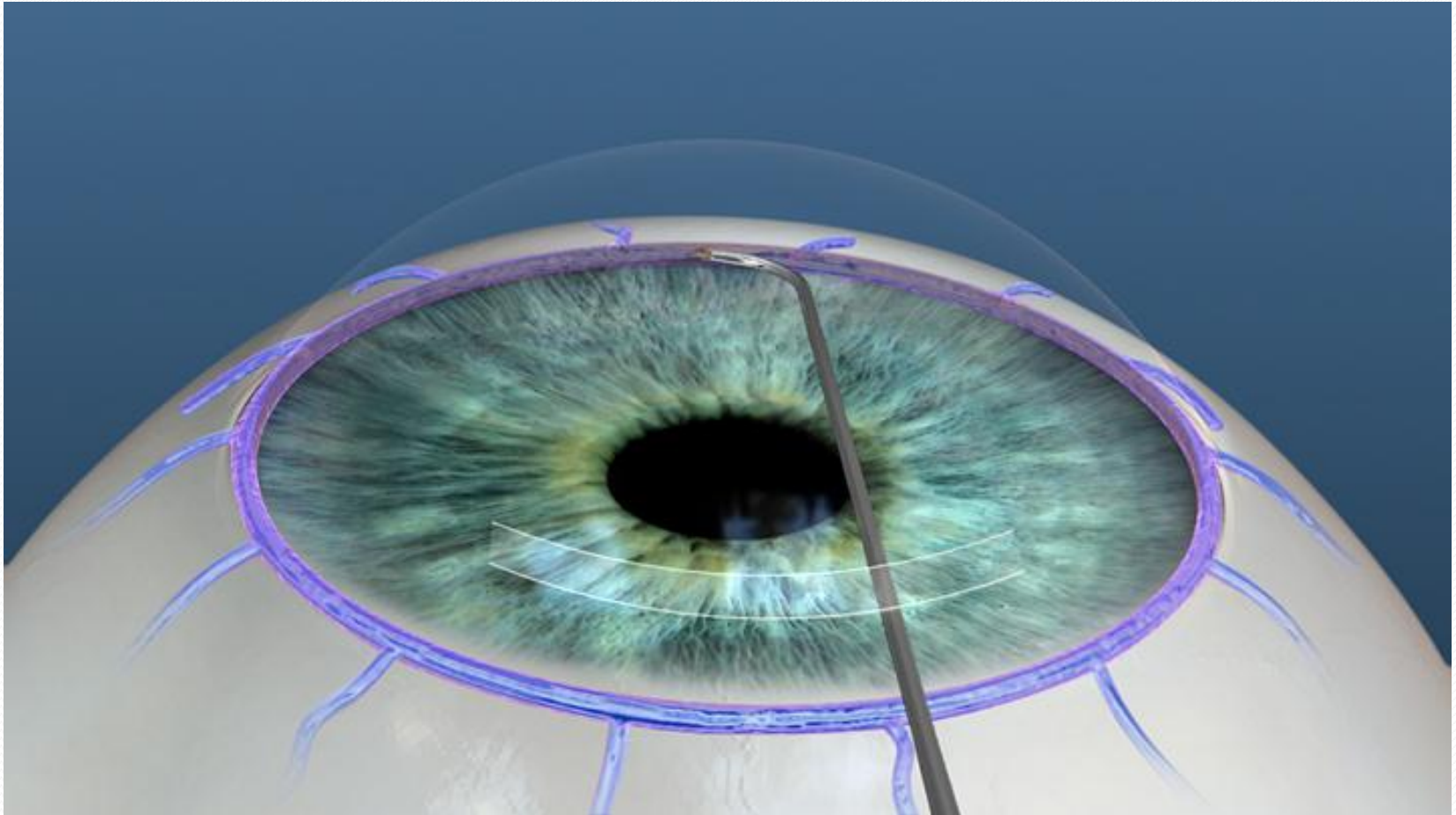

MIGS : Hydrus Microstent (*Ivantis, Inc*)

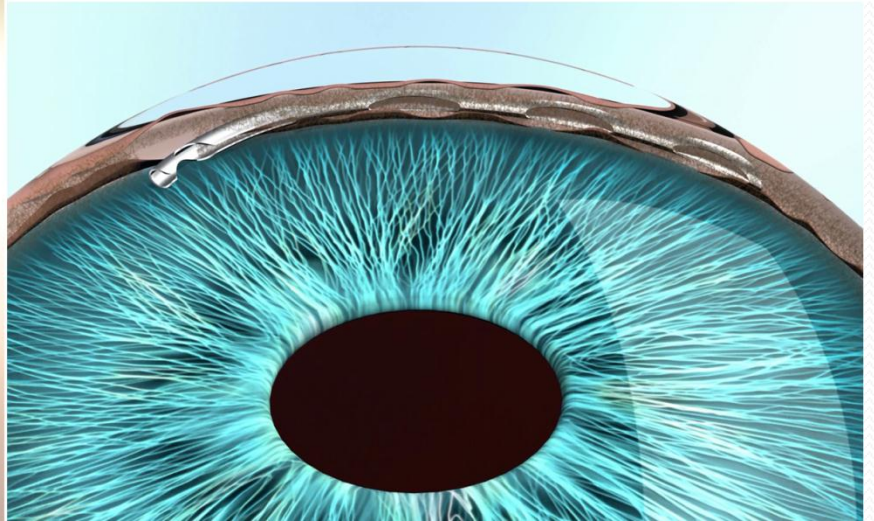
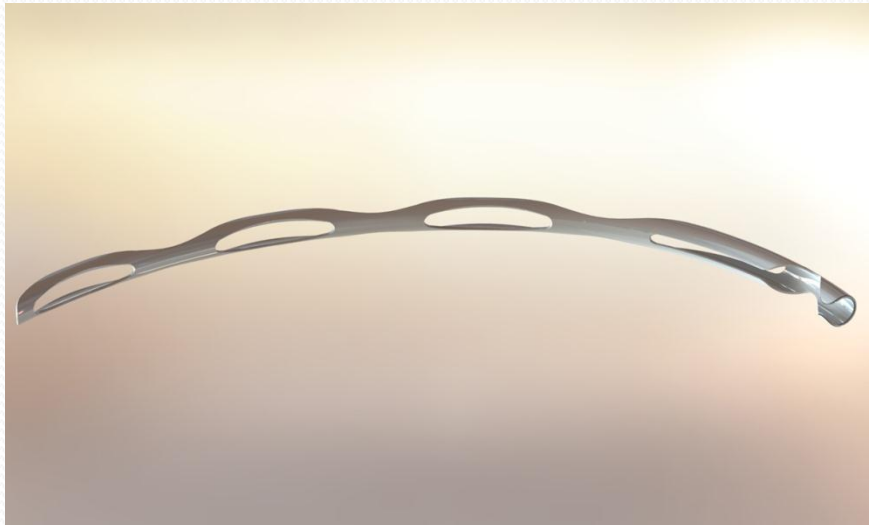

MIGS : Cypass Micro-stent (Alcon)

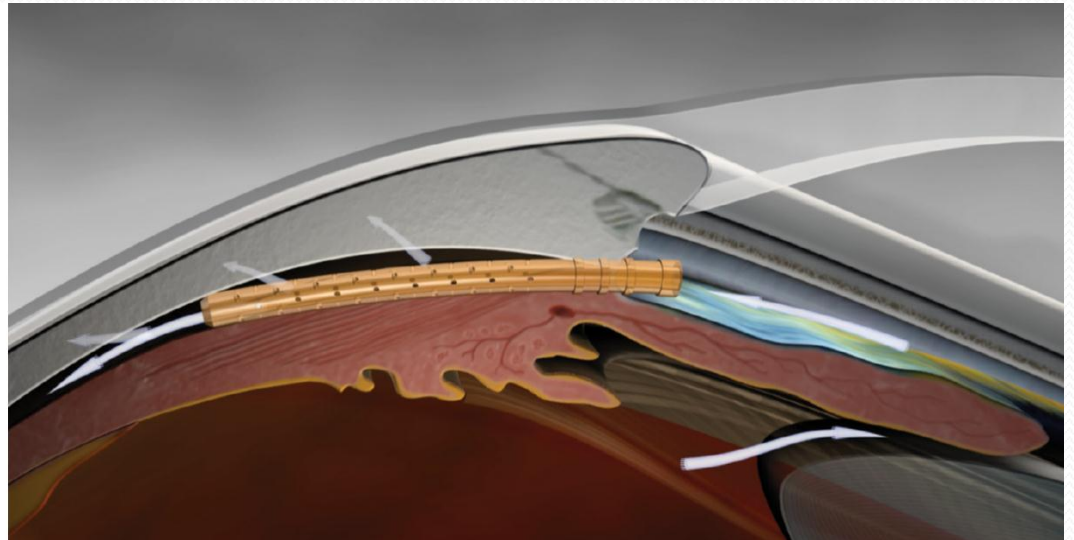

MIGS : istent SUPRA(*Glaucoose Corporation*)

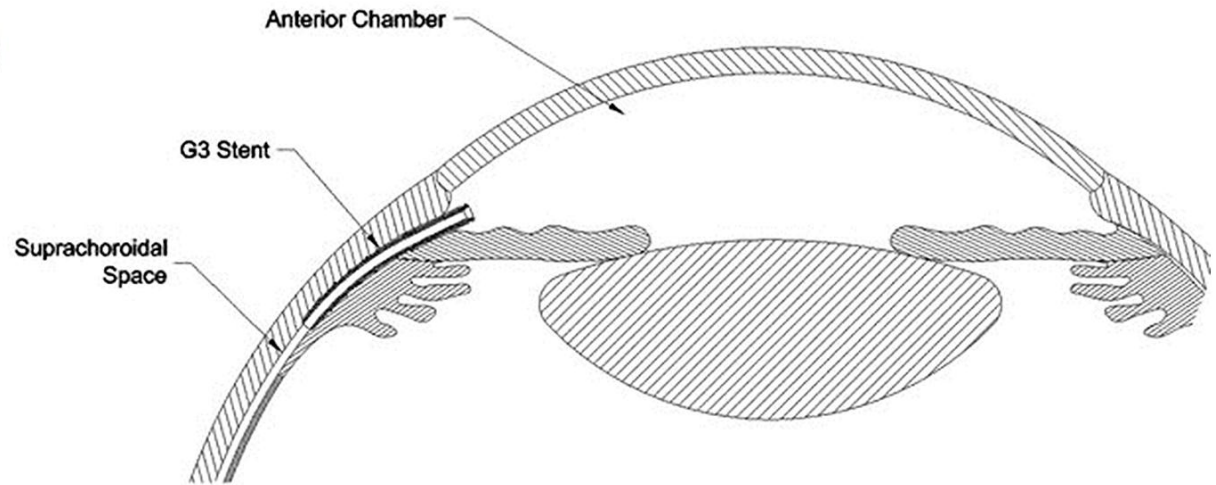

MIGS : istent SUPRA(*Glaucoose Corporation*)

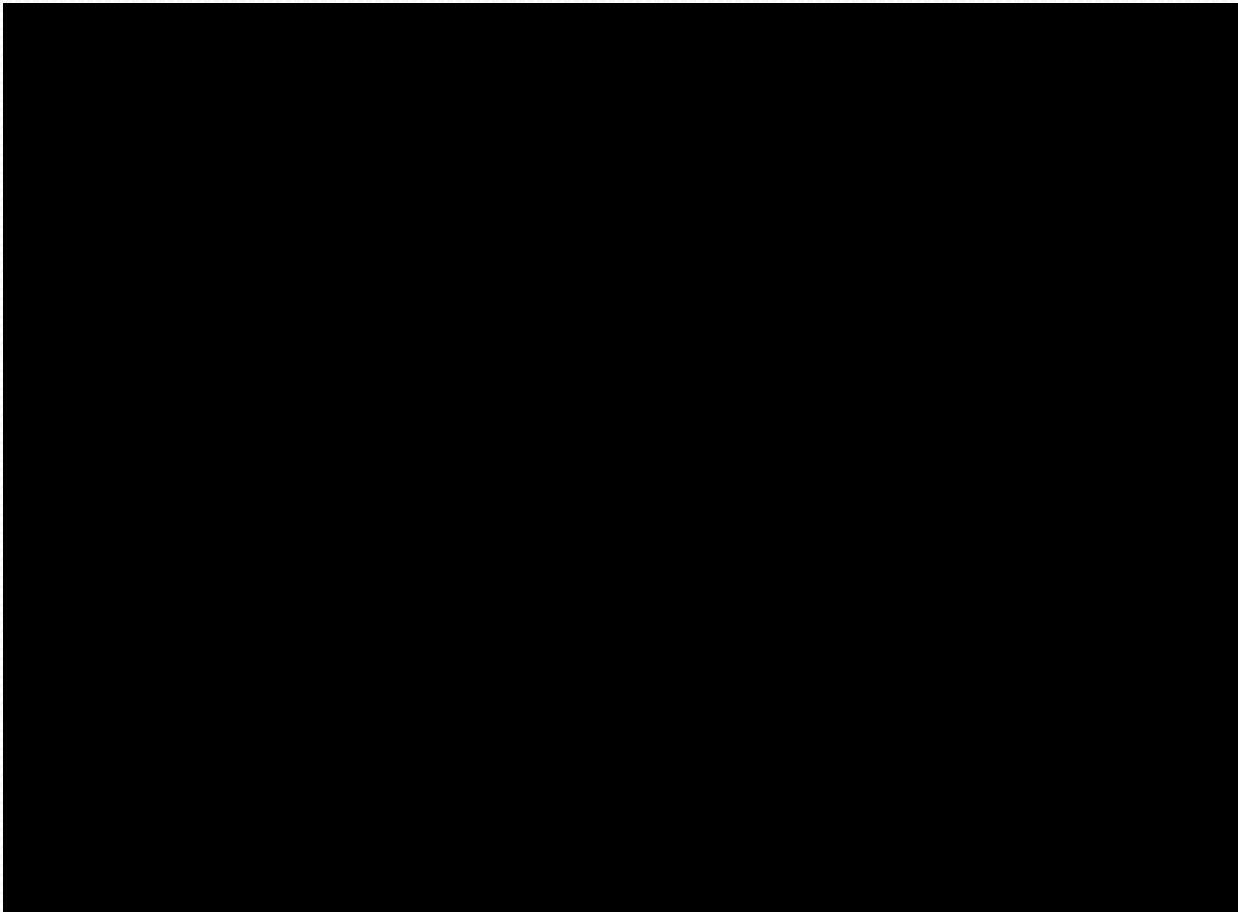

MIGS : XEN gel stent *(Allergan)*

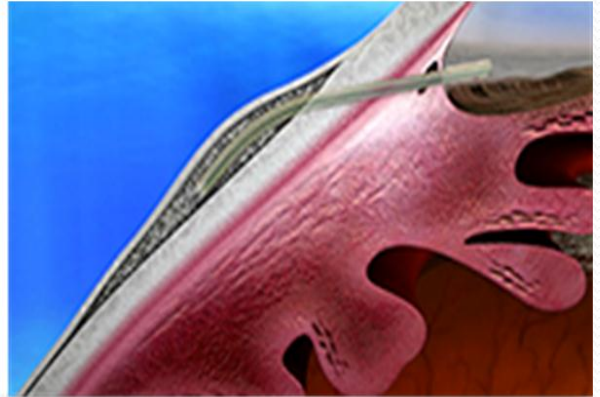
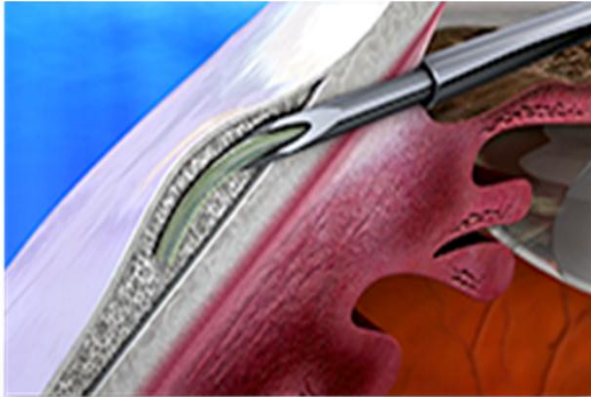
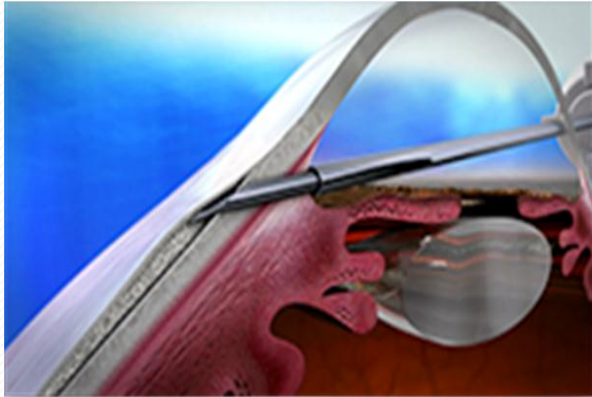

MIGS : XEN gel stent *(Allergan)*

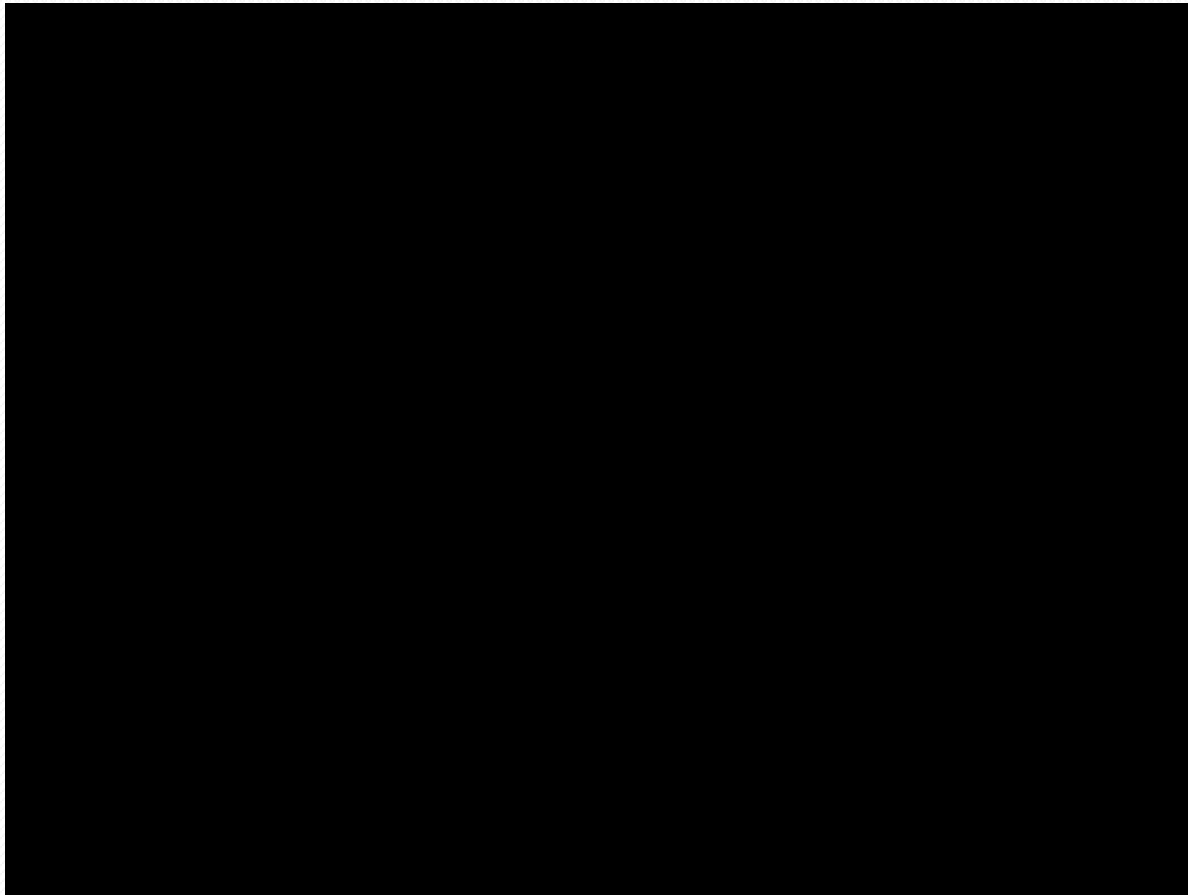

MIGS : InnFocus Microshunt

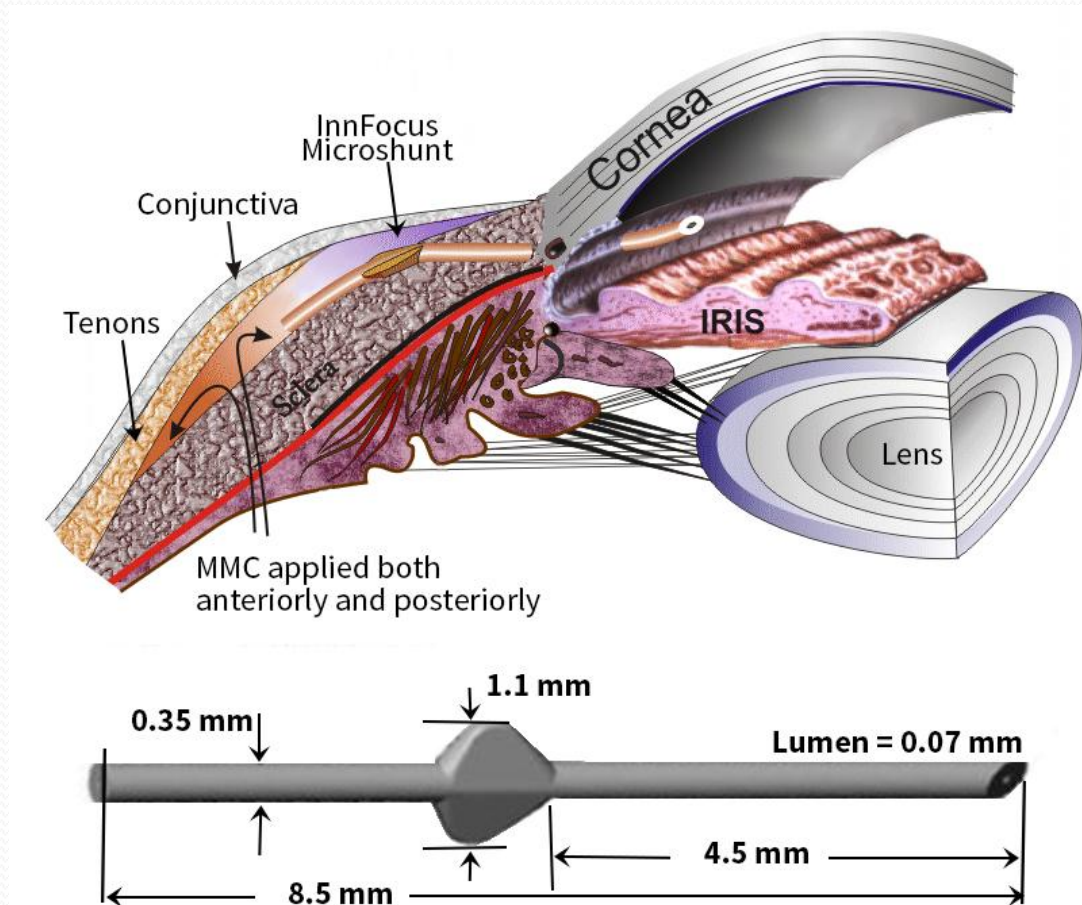

MIGS : InnFocus Microshunt

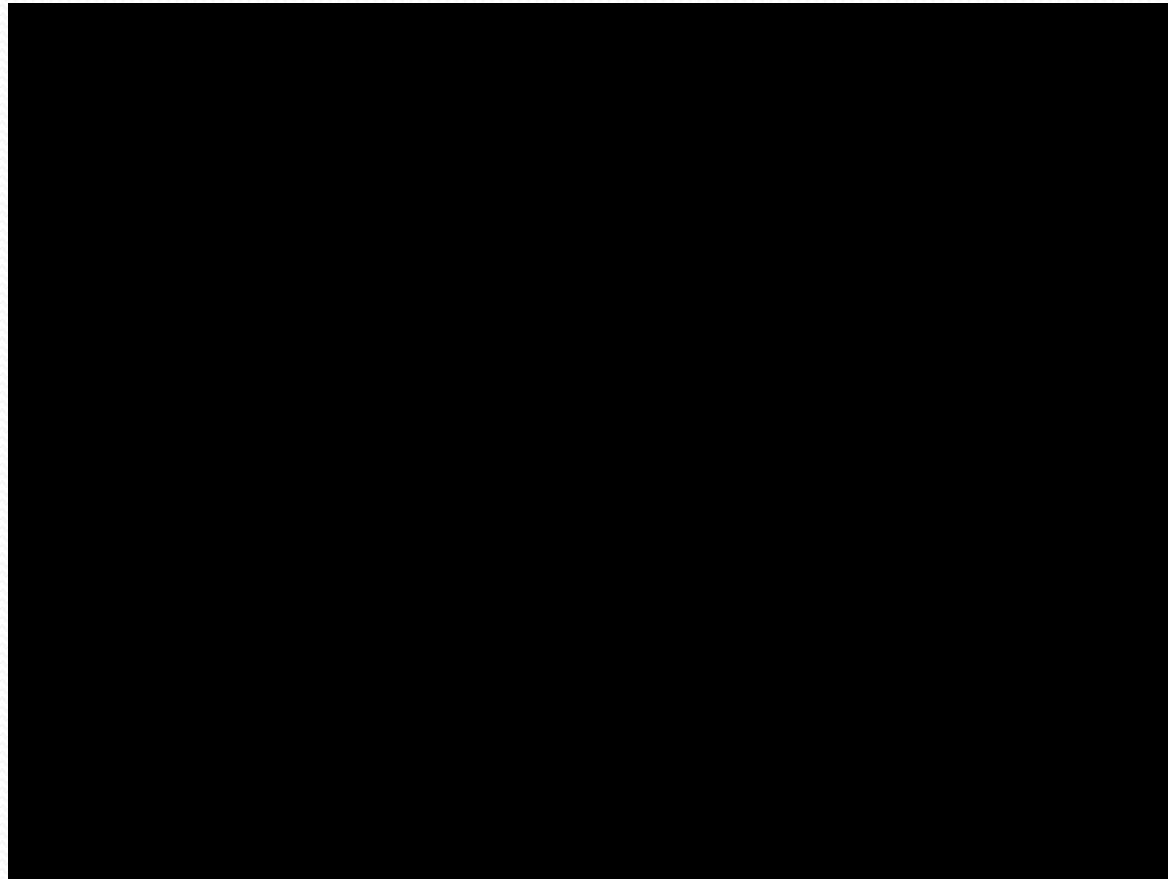

MIGS :ECP EndoCycloPhotocoagulation

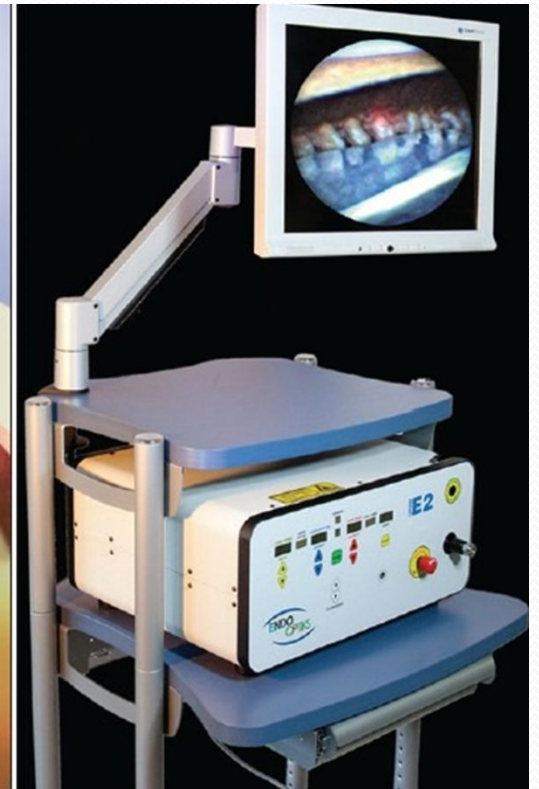
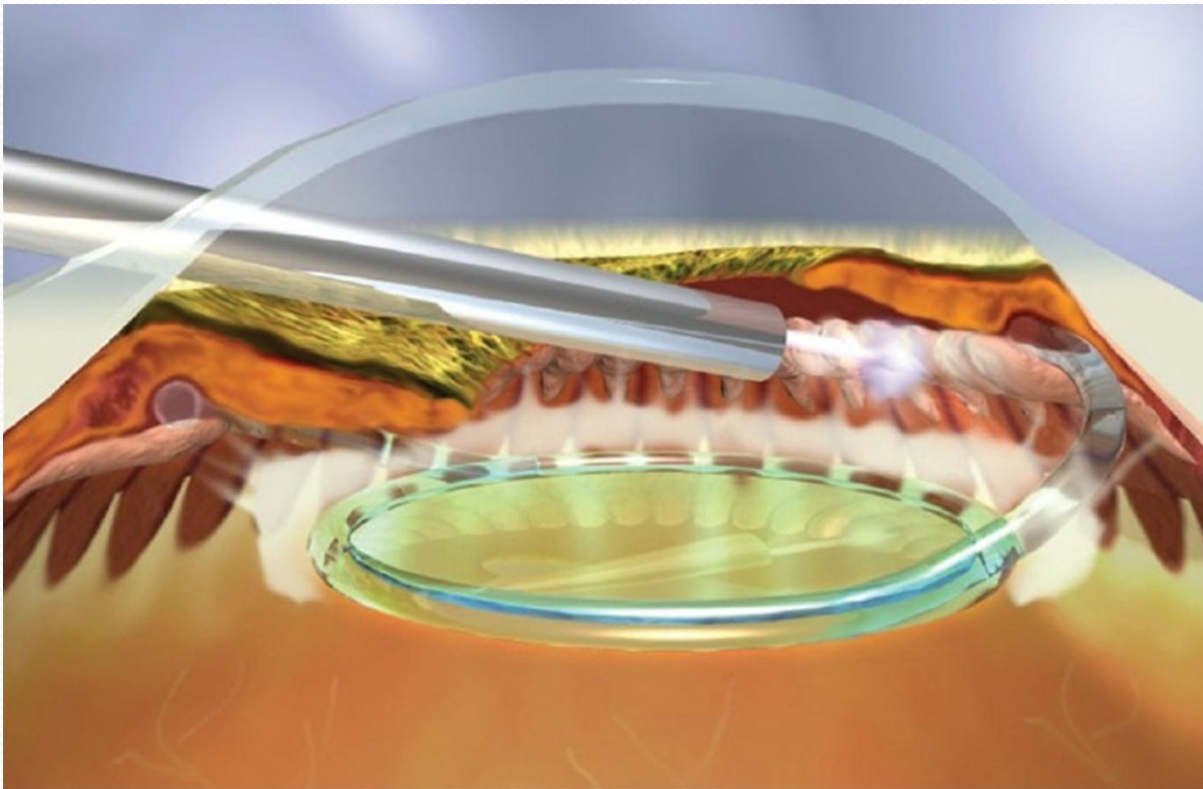

MIGS :ECP EndoCycloPhotocoagulation

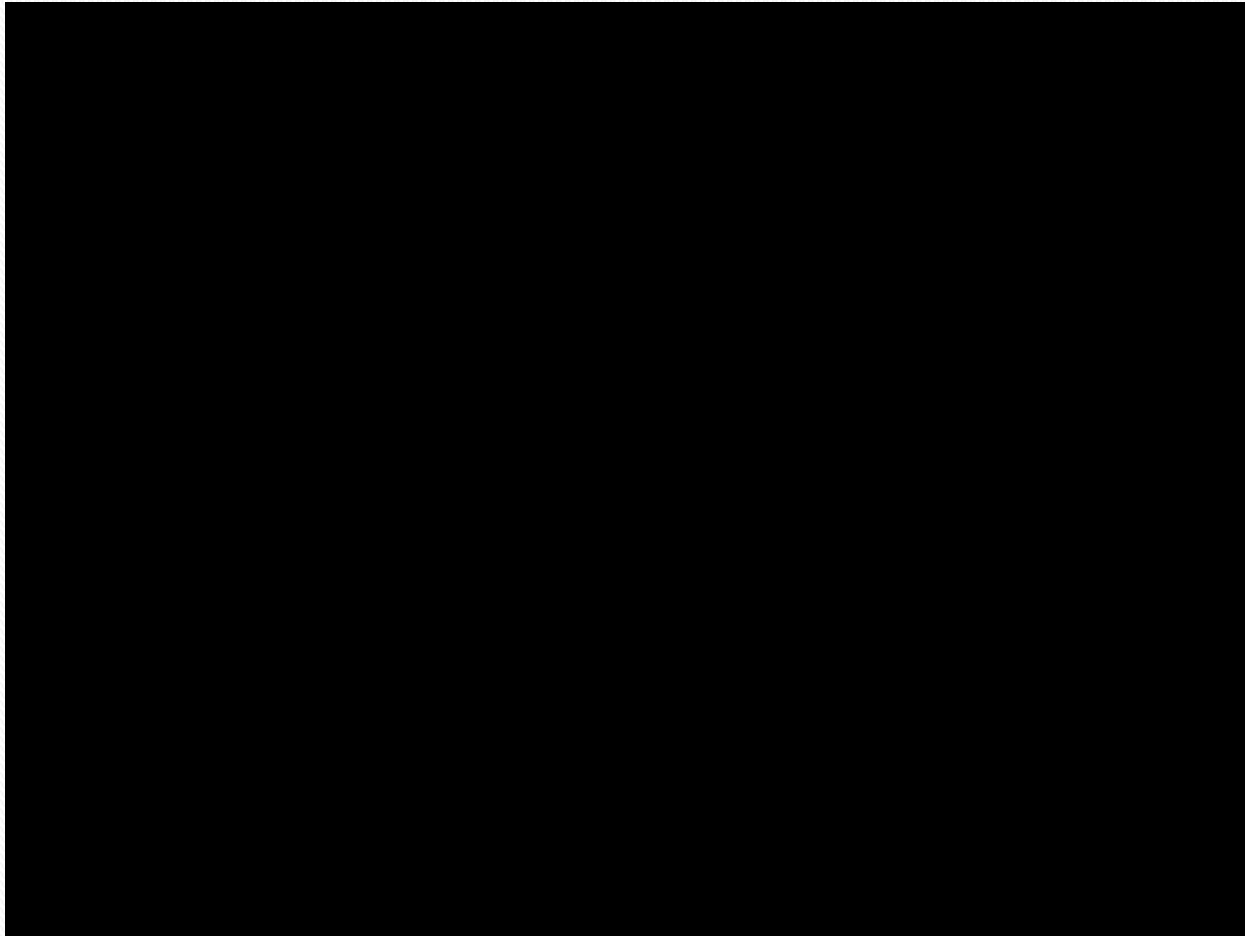

MIGS : relative effectiveness

MIGS Procedure	Decrease in IOP	Decrease in Medications	Study Type
iStent Micro-Bypass* [7]	8.4 mmHg @ 2 years	0.8 @ 2 years	Randomized controlled trial
iStent Inject [9]	8.1 mmHg @ 1 year	Not available	Prospective, randomized trial
Gonioscopy-assisted transluminal trabeculectomy (GATT)* [10]	8.4 mmHg @ 1 year	1.9 @ 1 year	Retro-spective review
Trabectome* [15]	6.2 mmHg @ 2 years	0.76 @ 2 years	Meta-analysis
TRAB 360	6.3 mmHg @ 1 year	0.9 @ 1 year	Retro-

TRAB 360 Trabeculectomy [16]	6.3 mmHg @ 131.5 days**	0.9 @ 131.5 days**	Retro-spective review
Ab interno canaloplasty* [18]	4.0 mmHg @ 1 year	1.0 @ 1 year	Case-series review
Hydrus Microstent* [20]	9.4 mmHg @ 2 years	1.5 @ 2 years	Randomized controlled trial
CyPass Micro-Stent* [22]	7.4 mmHg @ 2 years	1.2 @ 2 years	Randomized controlled trial
iStent Supra [23, 24]	7.8 mmHg @ 2 years	Not available	Prospective, single arm clinical trial
XEN Glaucoma	9.2 mmHg @ 1 year	1.8 @ 1 year	Prospective, single arm clinical trial

XEN Glaucoma Treatment System [27]	9.2 mmHg @ 1 year	1.8 @ 1 year	Prospective, single arm clinical trial
InnFocus MicroShunt* [31]	16.2 mmHg @ 3 years	1.6 @ 3 years	Prospective, single arm clinical trial
Endocyclophoto-coagulation* [35]	2.1 mmHg @ 2 years	1.1 @ 2 years	Prospective case-control study

MIGS :

- Cost

Cumulative Cost Per Patient (Canadian Dollar \$, 2014)						
	1 year	2 year	3 year	4 year	5 year	6 year
Trabec- tome	744.00	744.00	744.00	744.00	744.00	744.00
iStent	1044.00	1044.00	1044.00	1044.00	1044.00	1044.00
Endo- scopic Photo- coagul- ation	244.00	244.00	244.00	244.00	244.00	244.00
Medical Therapy						
Mono- drug	170.54	341.08	511.61	682.15	852.69	1023.23
Bi-drug	386.09	772.18	1158.28	1544.37	1930.46	2316.55
Tri- drug	528.12	1056.24	1584.36	2112.48	2640.60	3168.71



MIGS :

- conclusion